



# SPECIFICATIONS

- Voltage Rating: 300VAC/300VAC/300VAC
- Current Rating: 15 Amps/17 Amps/15 Amps
- Dielectric withstanding: 1.6KV/2.5KV/2.5KV
- Operating Temperature: -40°C to +115°C
- Contact Material: PhBz, Tin Plated
- Terminal Screw: Steel Zinc plating "-" slot type
- Insulator Material: Thermoplastic, UL 94V-0
- Wire Range: 2.5mm<sup>2</sup> /0.34-2.5mm<sup>2</sup>
- Wire Strip Length: 6-7mm
- Solid/Stranded Wire: 12-24 AWG
- Torque: 3.5Lb-In/0.5Nm/0.4Nm
- Clamp: Brass(CuZn) Ni plated
- Screw: M3
- Safety Approval:   



N = Number of contacts

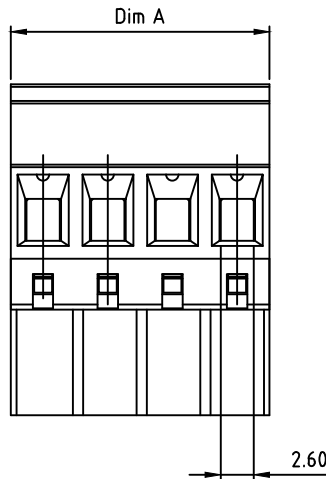
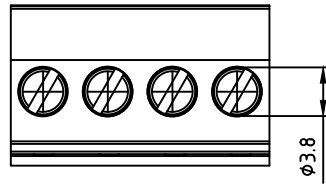
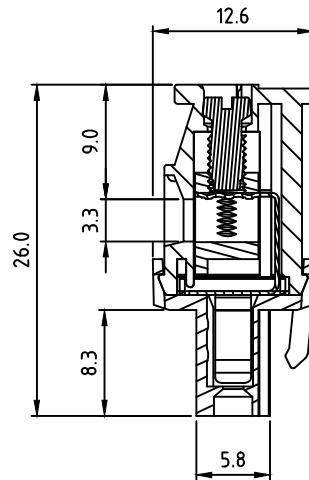
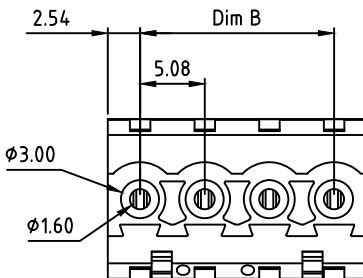

RPGH-XXEAX2-FG

02 pole  
 "" ""  
 24 pole

FG: RoHS Compliant  
 Pb<4000ppm

- J: Black(RAL9005)
- B: Red(RAL3001/D)
- C: Orange(RAL2011/P)
- D: Yellow(RAL1018/A)
- E: Green(RAL6018/T)
- F: Blue(RAL5015/A)
- H: Grey(RAL7035/D)

Dimensions	
A	N×5.08
B	(N-1)×5.08
Poles	Tolerance
2P-6P	±0.15
7P-12P	±0.20
13P-18P	±0.30
19P-24P	±0.40

GENERAL TOLERANCE UNLESS OTHERWISE SPECIFIED	
XXX. ± X	.XX ± 0.10
XX. ± X	.XXX ± X
X. ± 0.50	X.' ± 1'
.X ± 0.30	.X' ± 1'
REV. A	DRAWN
DATE 10/20/09	CHECKED
SCALE 1.9:1	APPROVED
UNIT mm	

**APTOS TECHNOLOGY**

RPGH Series  
 5.08 mm Side Entry Plug  
 PRODUCT NO. RPGH-XXEAE2-FG  
 FILE NAME: RPGH-XXEAE2-FG LF APD.DWG

APTOS Technology CONFIDENTIAL  
 This document, and all information it contains, are the confidential, proprietary property of APTOS Technology. Disclosure, duplication or distribution of this document, or any information it contains, in whole or part, without prior written permission from APTOS Technology is strictly prohibited